

Smart payment solutions made simple



Paynetics Product Brochure

PRINCIPAL MEMBER OF:



VISA



S€PA

PARTNER OF:

equensWorldline

Apple Pay

GPS

Paynetics

Introduction

Our vision at Paynetics is to make payments a frictionless and invisible process, that enables our clients to focus on their core business and supports their growth.

Paynetics offers a comprehensive range of payment solutions framed around a digital banking platform which includes card acquiring and issuing, account management, money transfers and eWallets.

We offer our clients a range of services all with the reliability and security of a regulated e-money institution, as a principal member of Visa, Mastercard, SWIFT and SEPA. But we also offer innovation at the speed of fintechs – we delivered the world's first Software POS (SoftPOS) terminal that works on any Android device, achieved the fastest integration of Mastercard Digital Enablement Services (MDES) in Europe and were the first financial institution to offer Apple Pay in the country.

Within this document, we have provided details of the complete range of payment services that we offer.

We can work with our partners and their clients to implement any of these services as “point solutions” within their organization. But the real benefit of working with Paynetics comes from working with us across a range of different service areas to drastically improve time to implementation for you, and time to cash for your customers.

We have a team of payment experts who helped introduce ATMs and chip cards to entire nations and re-established financial systems of whole countries. Whatever your payments challenge, we can help you meet it.

Benefits of working with Paynetics:



Regulated e-money institution

Principal member of Visa, Mastercard, SEPA, Swift; The first institution to offer Apple Pay



Highly flexible approach

We offer a flexible, modular approach to secure fintech payment infrastructure which enables rapid implementation for our partners



All payment services from a single source

Table of contents

Card Acquiring	4
Software Point of Sale	6
Card Issuing	8
BIN Sponsorship	10
IBAN Accounts	12
eWallet	14
Payment Tokenization	16
Money Transfer	18
Innovative Solutions	20

Card Acquiring

Overview

We're here to make card acquiring simpler, faster and more efficient for our partners and their customers.

We support businesses wherever and however they trade – online, off-line, in-store, in person or on-the-go.

We offer a range of flexible acquiring solutions for brick-and-mortar and online merchants, including the first purely Software Point of Sale (SoftPOS), which enables hardware-free contactless payments directly on Android phones.

We provide efficient on-boarding and quick underwriting, powerful and easy-to-integrate APIs, advanced anti-fraud technology as well as tailored analytics and reporting.

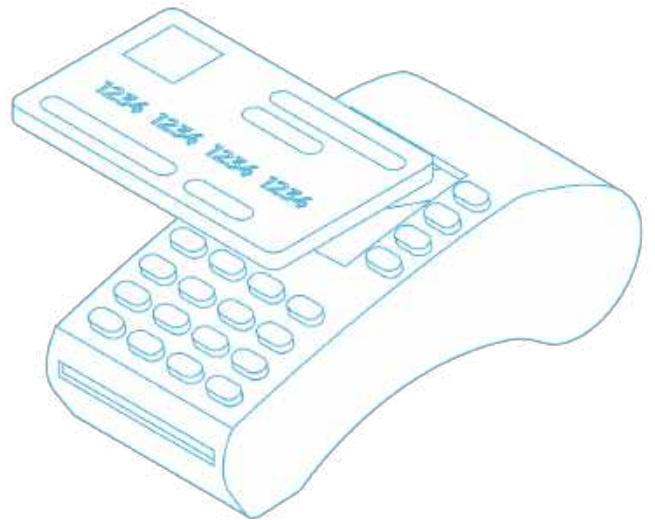

Benefits of working with Paynetics:



Omnichannel, to support any retailer

We provide card acceptance solutions for any environment – online, in-store or on-the-go via your phone



Extensive range of sector experience

We serve a wide range of verticals – retail, digital products, forex, cryptocurrency, and many more



Range of services to improve customer loyalty and your time to cash

IBAN accounts, eWallets and card issuing mean we can provide a broader range of services to improve your time to settlement

Why Paynetics for Card Acquiring?

Paynetics makes things easier for merchants with a comprehensive suite of acquiring services, including merchant on-boarding, PCI DSS compliance, fraud prevention, dispute and risk management, tailored for each specific business model.

We provide a fully PCI DSS compliant payment platform which is easily integrated into online shops and provides a one-stop solution for eCommerce, mCommerce, eWallet and industry specific alternative payment channels.

Software Point of Sale

Overview

Our Software Point of Sale (SoftPOS) can help simplify the move from cash to contactless payment for millions of merchants.

Phos, in partnership with Paynetics, has created an innovative payment acceptance solution which turns any NFC-enabled Android smartphone into a Point of Sale terminal. Merchants in every sector can download this SoftPOS system on any NFC-enabled Android device, and start accepting payments immediately, creating a checkout experience that is convenient, seamless and intuitive.

Merchants can accept payments from contactless cards, mobile wallets, and wearables. And, because this is a software Point of Sale, all this can be done with no additional devices, separate dongles or other hardware.

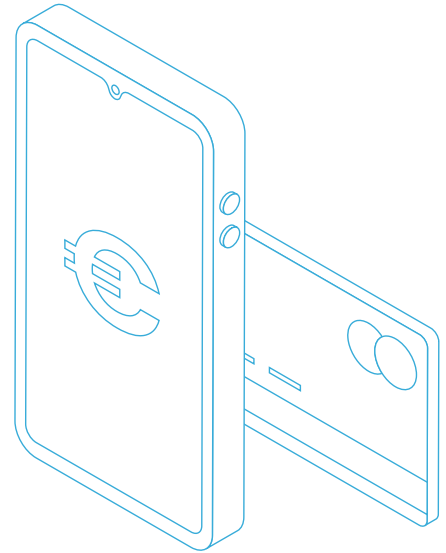

Benefits of working with Paynetics:



No additional hardware

Merchants can use technology that they already have – their mobile phone or other Android device



High-speed implementation

Frictionless onboarding process and intuitive mobile app interface



Lower costs

In addition to saving on hardware, we are able to offer lower transaction fees



Improved time to cash

Fast settlement and instant access to funds with a Business Card issued by Paynetics



Why Paynetics for SoftPos?

SoftPOS can help reduce the cost of accepting contactless and mobile payment, and bring in an estimated of 15 million additional merchants into the payments ecosystem in the next few years. By including our SoftPOS in their portfolio our partners can:

- Attract new clients - Claim their share of the millions of unserved merchants who currently only accept cash
- Reduce the total cost of ownership of traditional hardware POS infrastructure
- Generate new lending opportunities with better risk and cash management control
- Create new revenue streams by monetizing additional value-added services which can be offered with the mobile app

Card Issuing

Overview

As a principal member of Visa and Mastercard, Paynetics supports the full range of card options of these two card schemes – consumer and business; debit, credit, prepaid, gift cards, single use and reloadable cards; plastic, virtual or digitized.

Our card issuing programs are fully customizable to your business needs. Superior rule settings give you full control over issued cards whilst customized card designs enhance your brand and create the perfect payment experience.

Our API platform ensures a quick on-boarding and efficient data exchange between systems for Paynetics and our partners. In addition to the fully digital onboarding process, it also covers compliance, risk analysis and monitoring.



Benefits of working with Paynetics:



Full range of payment cards

Plastic, virtual or digitized, prepaid, debit, credit or business.



Customizable for your brand

Co-branding and flexible rule settings to enhance your brand and drive business growth



API platform for efficient on-boarding

Fully digital on-boarding process available via our API platform

Why Paynetics for Card Issuing?

While plastic cards are still widely in circulation, virtual cards are on the rise, following the shift to eCommerce. Paynetics offers them both.

We are able to offer cards in a wide range of currencies and support multiple currency transactions. Having this flexibility, coupled with the superior rule settings, allows program managers to craft their programs dynamically and quickly respond to customer demand.

We also utilize the latest in payment tokenization technology to ensure security. Our tokenized cards offer a lower transaction risk, reduce authorization declines and help merchants process a higher volume of transactions.

Our cards can also be used within our eWallet application, providing consumers with a range of further benefits, and merchants with much richer data at point of transaction.

BIN Sponsorship

Overview

BIN sponsorship with Paynetics is the fastest and simplest way to launch a payment card program, significantly shortening the time to market.

Through our BIN Sponsorship we can help you bring VISA and Mastercard payment cards to your business quickly and conveniently. Direct scheme membership can be costly, complex and time consuming. We empower you to manage your own programs such as eWallet accounts, prepaid cards or debit cards without the need for an individual e-money license or direct scheme membership.

A scheme-assigned BIN (bank identification number) enables companies with an established client base and business model to deploy their own cards or eWallets without being a direct member of these card schemes. This greatly improves the speed of implementation of a card program.

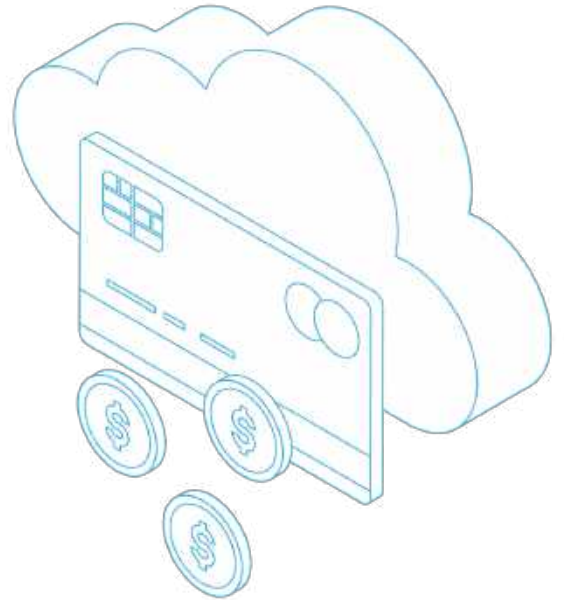

Benefits of working with Paynetics:



Speed of implementation

Shorten the time to market for your own payment cards or wallets



Simpler process

Focus on your clients, we cover all the regulatory requirements



Full toolset

Benefit from our wide range of additional payment products

Why Paynetics for BIN Sponsorship?

Our status as an e-money institution means that our partners can perform many of the operations of a financial institution through us.

As Principal Members of both Mastercard and Visa, we assist businesses to have their own eWallet and run their own card programs.

IBAN Accounts

Overview

We can simplify cross-border payments by providing you with your own multi-currency International Bank Account Number (IBAN).

As a principal member of SWIFT and SEPA we offer fully functional IBAN accounts with the same facilities as regular bank accounts, but reducing administrative costs and complexity for you.

Our clients, individual or business, receive a dedicated IBAN for SEPA and international payments.



Benefits of working with Paynetics:



Support global money transfer

Multi-currency IBANs for cross border payments



Faster, simpler process

Fast, easy, and reliable way to get your own IBAN



API Platform for automatic IBAN creation

Remote account opening and IBAN creation can all be delivered via our API platform



Why Paynetics for IBAN Accounts?

We have automated the process so that you can get your IBAN in just a few quick steps.

The process is fully digital with a minimum set of required documentation. Our partners can create and offer IBANs in their own name or their customer's name, open European and international markets to their customers and expand the potential of their businesses.

We have developed an API Platform which allows our partners to create their IBANs automatically, with no human interaction required. The API Platform also allows you to receive real-time information about transfers and balances. Opening and managing IBANs via our API Platform will enable you to efficiently monitor and manage your payments.

eWallet

Overview

The Paynetics eWallet can be a digital platform for growth for retailers.

Our eWallet provides a seamless user experience which enables consumers to make payments directly from their phones either online or in-store. Our interoperable eWallets connect shoppers with merchants creating value for both parties.

For the consumer, spending analytics, payment notifications, full card control, cashback and digitalization of loyalty cards, vouchers and coupons all offer huge benefits.

For the merchants, a customizable app for vouchers and loyalty cards can drive repeat business and generate increased demand.

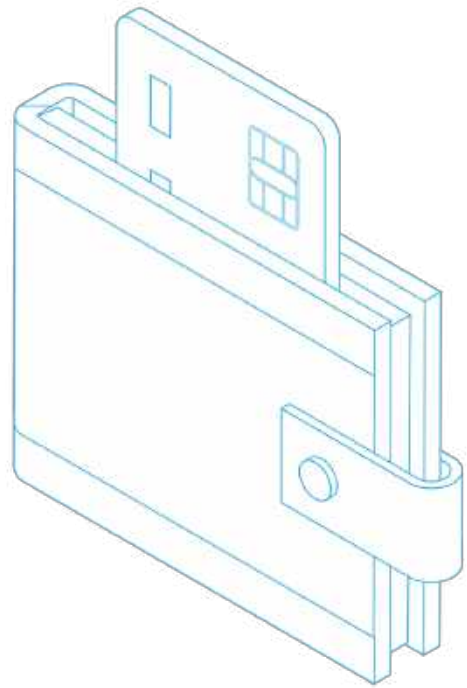

Benefits of working with Paynetics:



Simpler, faster implementation

Our eWallet proposition combines Software as a Service with Payments as a Service, significantly reducing time to market for our partners



Best-in-class security

Industry-leading security protocols including payment tokenization ensure the safe flow of payments data

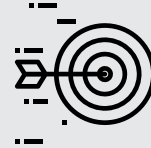

Greater efficiency

Lower fraud risk, reduced transaction fees, and an effective way for businesses to reach new customers

Why Paynetics for eWallet solutions?

Through our white label eWallet solution, we empower our partners to offer digital banking and financial services in a short period of time.

We have implemented a commercial eWallet solution from a client within just three months of signing a contract.

Payment Tokenization

Overview

Our payment tokenization solutions bring transactions to the mobile phone and help reduce fraud in digital transfers.

For each transaction, sensitive details are replaced by dynamic components to secure the transmitted information, provide faster check-out experience and ultimately more options for merchants to accept payments.

We support both Android and Apple phones. For Android OS we use our proprietary technology, which is built on the basis of MasterCard Digital Enablement Service (MDES) protocol. MDES helps enable any connected device to be “commerce ready” to make and receive payments. The MDES platform enables secure payments to take place for contactless and in-app payments on mobile. For iOS we support ApplePay.

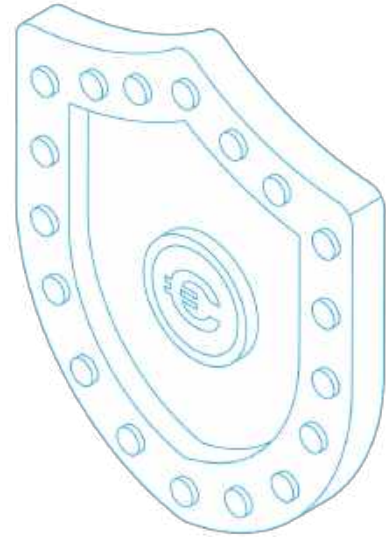

Benefits of working with Paynetics:



Mobile device-agnostic

Payment cards directly on the mobile, for both iOS and Android



Best-in-class security

Industry-standard EMV-level security and dynamically encrypted elements means both best-in-class reliability and speed



Highly versatile

Our eWallets can support a range of different use cases, and create new revenue opportunities for our clients

Why Paynetics for Payment Tokenization?

Tokens can be used for mobile point-of-sale transactions, in-app purchases or online purchases. From a business perspective, our tokenized cards drive innovation and reduce risk.

With the lower transaction risk, authorization declines are also reduced, significantly reducing friction and supporting trade.

As more and more consumers are moving to digital payments and using cards within eWallets, and as mobile and software point of sale proliferates, payment tokenization is a “must have” to keep services both competitive and secure.

Money Transfer

Overview

At Paynetics, we offer frictionless end-to-end payment and banking solutions from one trusted partner.

Money transfers are a key part of how our clients manage their finances. So we provide our clients with access to a very broad, reliable, flexible and secure fintech payment infrastructure to move funds.

As a principal member of SEPA and SWIFT, we execute online money transfers instantly, allowing our customers to expediently execute their orders. Euros within the Single European Payment Area (SEPA) are transferred through our direct clearing participation, which saves money and time on European transfers.

Payments outside the SEPA are made via the Society for Worldwide Interbank Financial Telecommunications system (SWIFT).

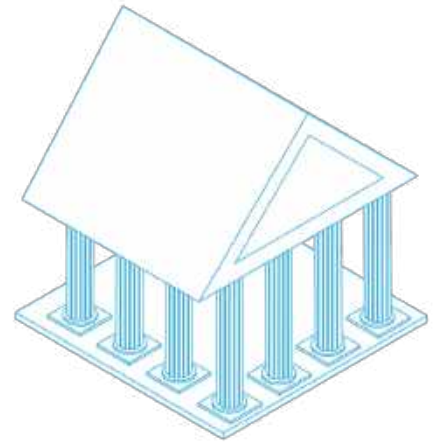

Benefits of working with Paynetics:



Support for extensive range of currencies

Settlement in various currencies and multiple payment options, including EUR, GBP, USD, BGN, and RON



Regulated e-money institution

Principal member and directly plugged into SEPA and SWIFT



Extensive range of options

SEPA, International, Internal, Batch payments, Peer-To-Peer, Pay by Link, QR Pay, Card Loading and more.



Multiple SEPA products

including SEPA Credit, Direct Debit and SEPA Instant.



Why Paynetics for Money Transfer?

We can provide a money transfer service to help your business as you expand globally, and transact in multiple currencies.

And our service is designed to further support your growth by speeding-up money transfer, to help you improve your liquidity, streamline working capital and, ultimately, reduce costs.

Innovative Solutions

Overview

Our mission at Paynetics is to simplify payment solutions.

We have at our disposal an extensive product set and we make that available to our clients to support the full range of use cases that they may have.

We offer our clients the convenience of comprehensive payment services from a single source:

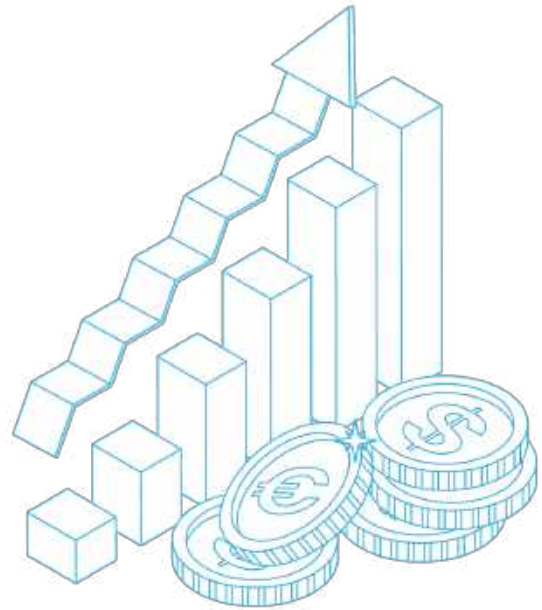

Omnichannel acquiring

Flexible solutions, efficient on-boarding, easy-to-integrate APIs



Card issuance

Plastic, virtual or digitized cards issues for both Mastercard and VISA schemes, to meet all possible use cases



Digital banking platform

Our white label eWallets offer seamless experience and are packed with features



Payment tokenization

Allows you to bring payments to the mobile phone and help reduce fraud



A range of banking services

IBAN accounts, bank transfers, FX, etc.- [click here](#)

When we combine our products and services to create solutions for clients, we can deliver game-changing improvements in time to implementation, time to settlement and, ultimately, time to cash.



By combining issuing and acquiring we can help merchants to improve working capital, shorten time to cash, reduce charge backs and ultimately enhance profitability.



When we issue cards, we can link them to dedicated IBAN accounts, substantially improving the value proposition and creating a range of opportunities for product innovation. We make our physical and virtual cards bankable, which creates a platform for further opportunities for our partners.



A wide range of possibilities can be opened up within our eWallets by integrating payment cards. Our partners can use our adaptable technology to create a payment flow matching the needs and specifications of your platform. This creates an easy, fast, and convenient way to send and receive money.



BIN sponsorship is the fastest, most convenient way to launch a payment card program, significantly shortening the time to market. A scheme-assigned BIN enables companies with an established client base to deploy their own cards or wallets without needing direct membership of the Mastercard or VISA card schemes.



Settlements in different currencies and via different payment options. Our clients are able to make a range of transfers or payments: SEPA transfers, International transfers, Internal transfer, Batch payments, Peer-To-Peer, Pay by link, Card Loading, Direct Debit, Payment Card.



We have also linked money transfers to the QR payment rails, which are part of the Paynetics infrastructure. Using the QR interface for money transfers speeds up checkout, reduces transaction costs and ensures a superior user experience.



Software POS can be a gateway to opening up a whole new set of additional benefits to increase customer loyalty, improve cash-flow and time to settlement. Our SoftPOS enables fast settlement of processed payments, with instant access to funds via Paynetics Business Cards, a number of value-added services like loyalty programs, and alternative payment methods, such as QR codes.



PAYNETICS

office@paynetics.digital

+359 2 806 56 15

+ 44 (20) 808 909 62